

9881296COMUK

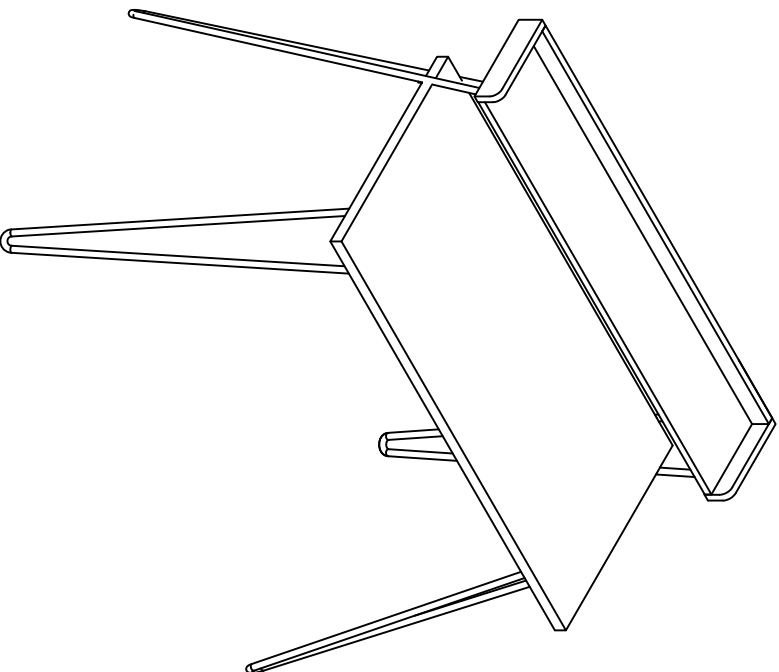

THIS INSTRUCTION BOOKLET CONTAINS **IMPORTANT** SAFETY INFORMATION. PLEASE READ IT CAREFULLY AND KEEP FOR FUTURE REFERENCE.

Do Not Return This Product!

Contact our customer service team for help first.

Call: 01942 524100

Visit: CSEurope@dorel.com

Dorel Home Furnishings Europe Ltd.
Building 4, Imperial Place, Maxwell Road
Borehamwood WD6 1JN United Kingdom

WARNING

- Unit can tip over causing severe injury or death.
- Anchor unit to stud in wall (if instructed to).
- Do Not allow children to climb on unit.
- Put heavy items on lower shelves or drawers.

Recommended no. of people needed for assembly : 2

Before starting

- Read each section carefully before starting. It is very important that each step is performed in the correct order. If these steps are not followed in sequence, assembly difficulties will occur.
- Make sure all parts are included. Most board parts are labeled or stamped on the raw edge.
- Work in spacious area, preferably on a carpet, near the place the unit will be located.
- Have the following tools close at hand.
- Do not use power tools to assemble your furniture. Power tools may strip or damage the parts.

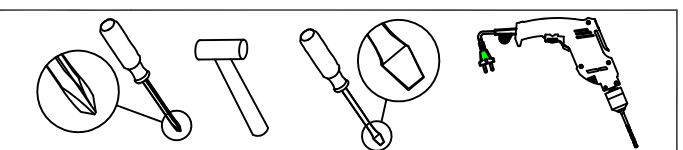

HELPFUL HINTS

- Identify, sort and count the parts before beginning assembly.
- Compression dowels should be tapped in with a rubber mallet.
- Slides have a lip on the right side only.
- Back panels provide stability and support.
- Unit may collapse without the back panel installed.
- Clean the product with your choice of furniture polish and a soft cloth. **DO NOT USE** harsh chemicals or abrasive cleaners.
- Move your new furniture carefully. Two people are needed to lift and carry the unit to its new location.
- Never push, drag or scoot your furniture (especially on a carpet).

Cam Lock Fastening System

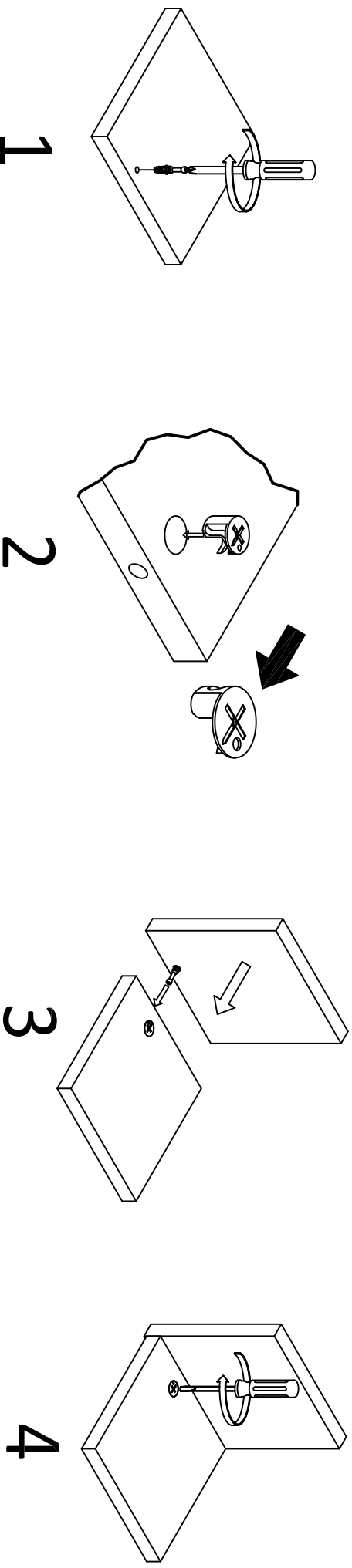

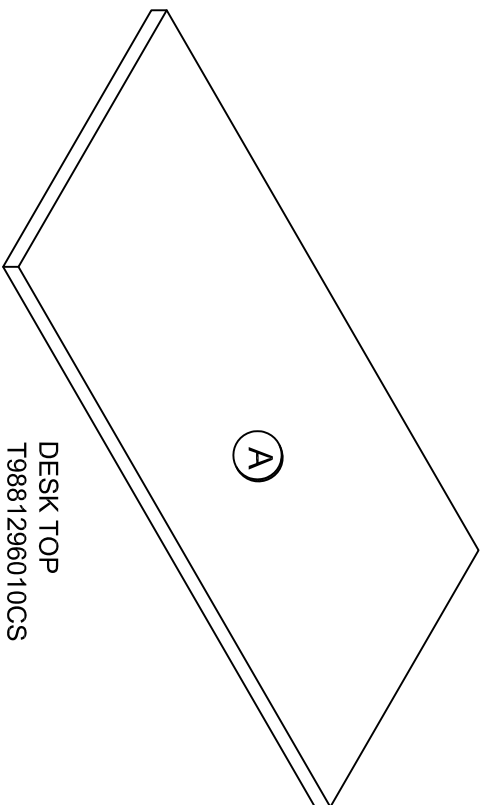

DESK TOP
T9881296010CS

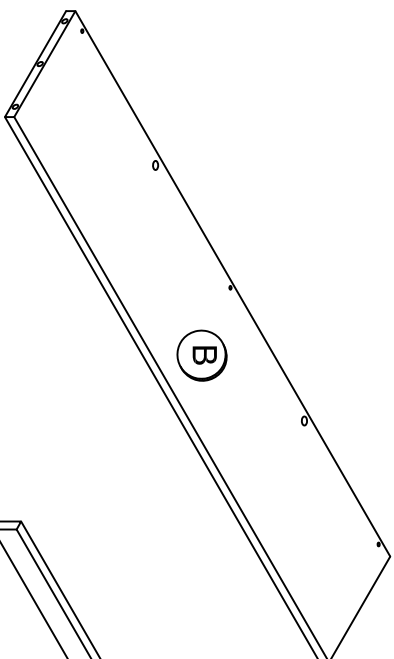

HUTCH TOP
T9881296020CS

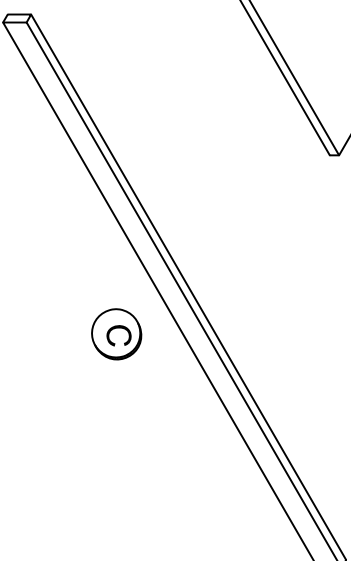

BACK PANEL
T9881296030CS

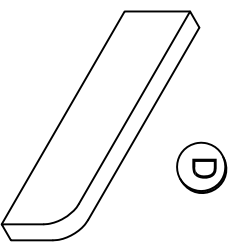

LEFT SIDE PANEL
T9881296040CS

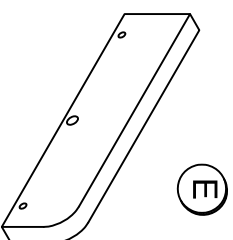

RIGHT SIDE PANEL
T9881296050CS

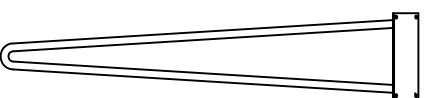

FRONT LEG
T9881296060CS
QTY: 2PCS

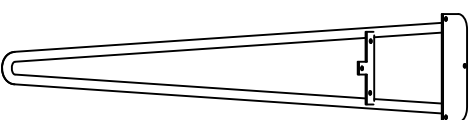

REAR LEG
T9881296070CS
QTY: 2PCS

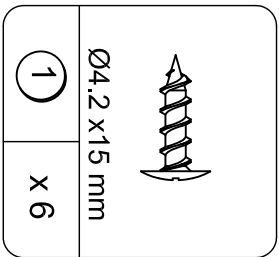

SCREW
TCS1065

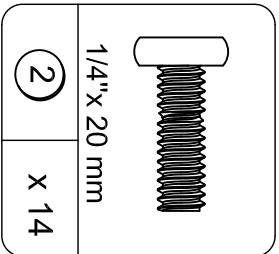

BOLT
TCS1114

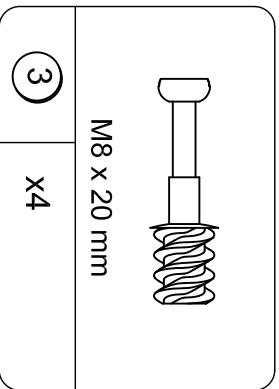

CAM BOLT
TCS2010

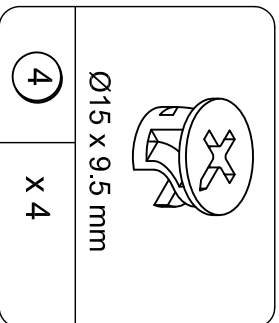

CAM LOCK
TCS2013

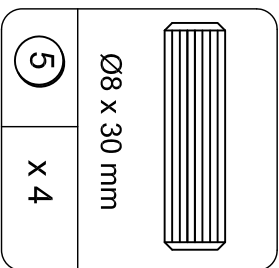

WOOD DOWEL
TCS3002

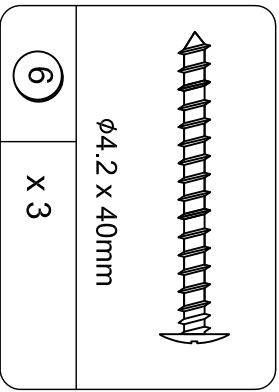

SCREW
TCS1059

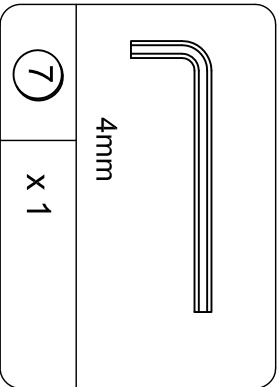

HEX KEY
TCS6001

1

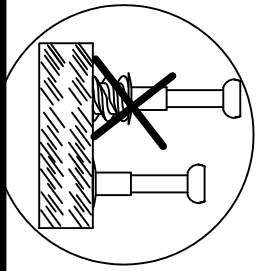
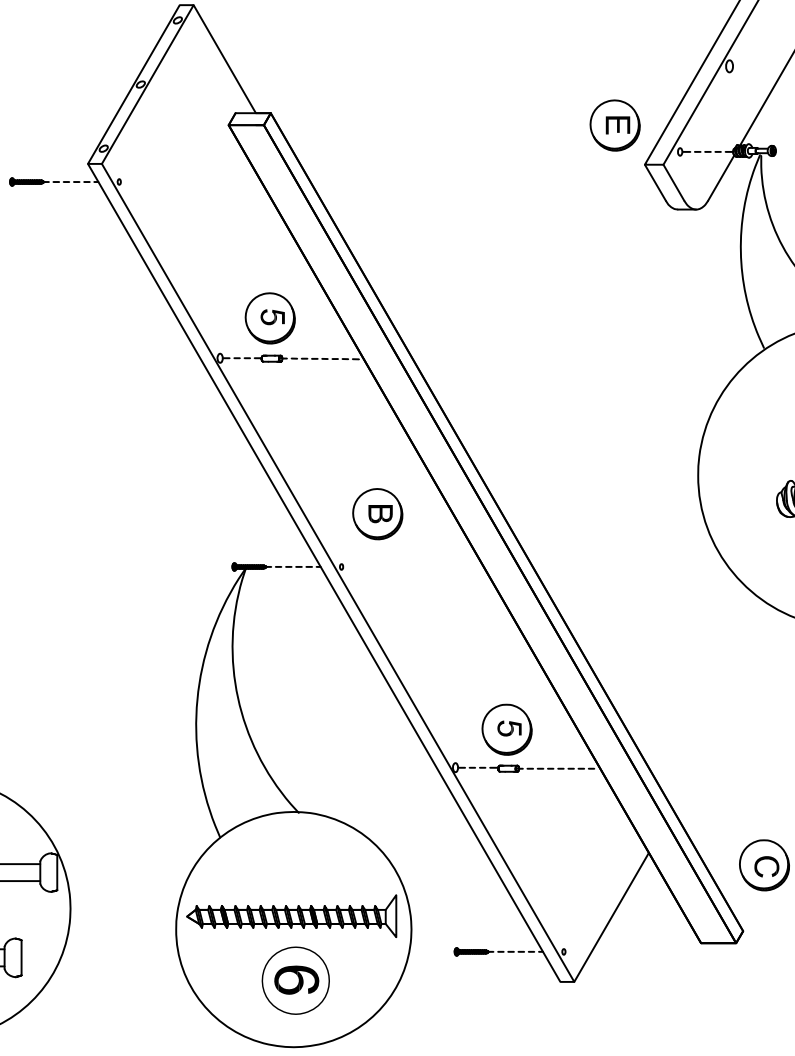
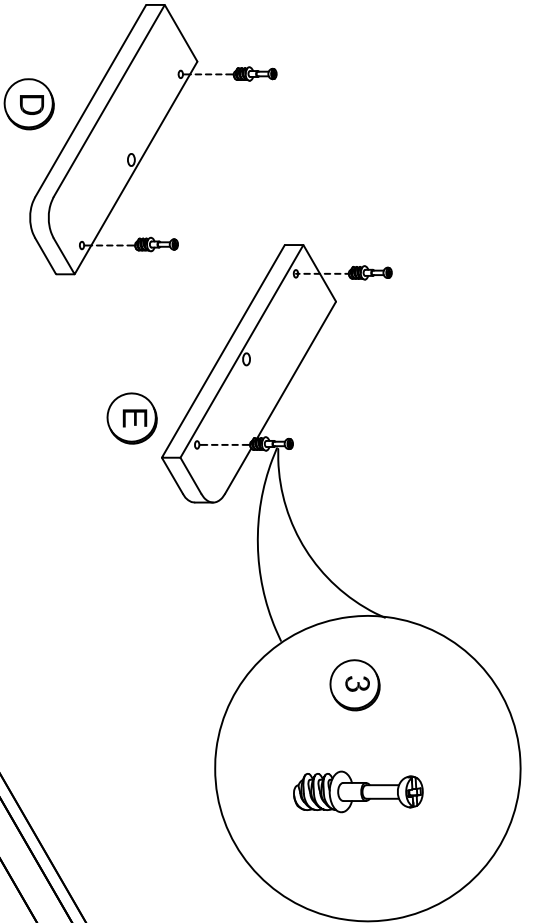
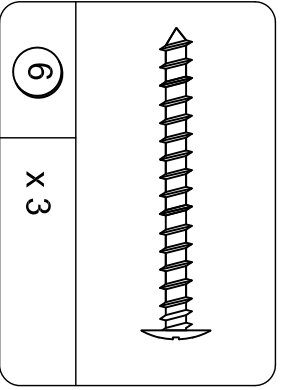
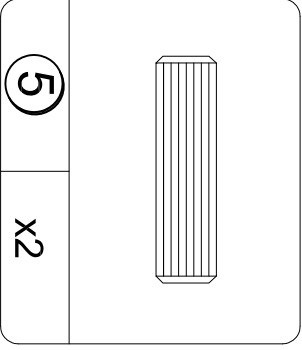
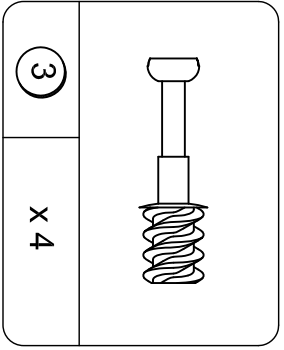

2

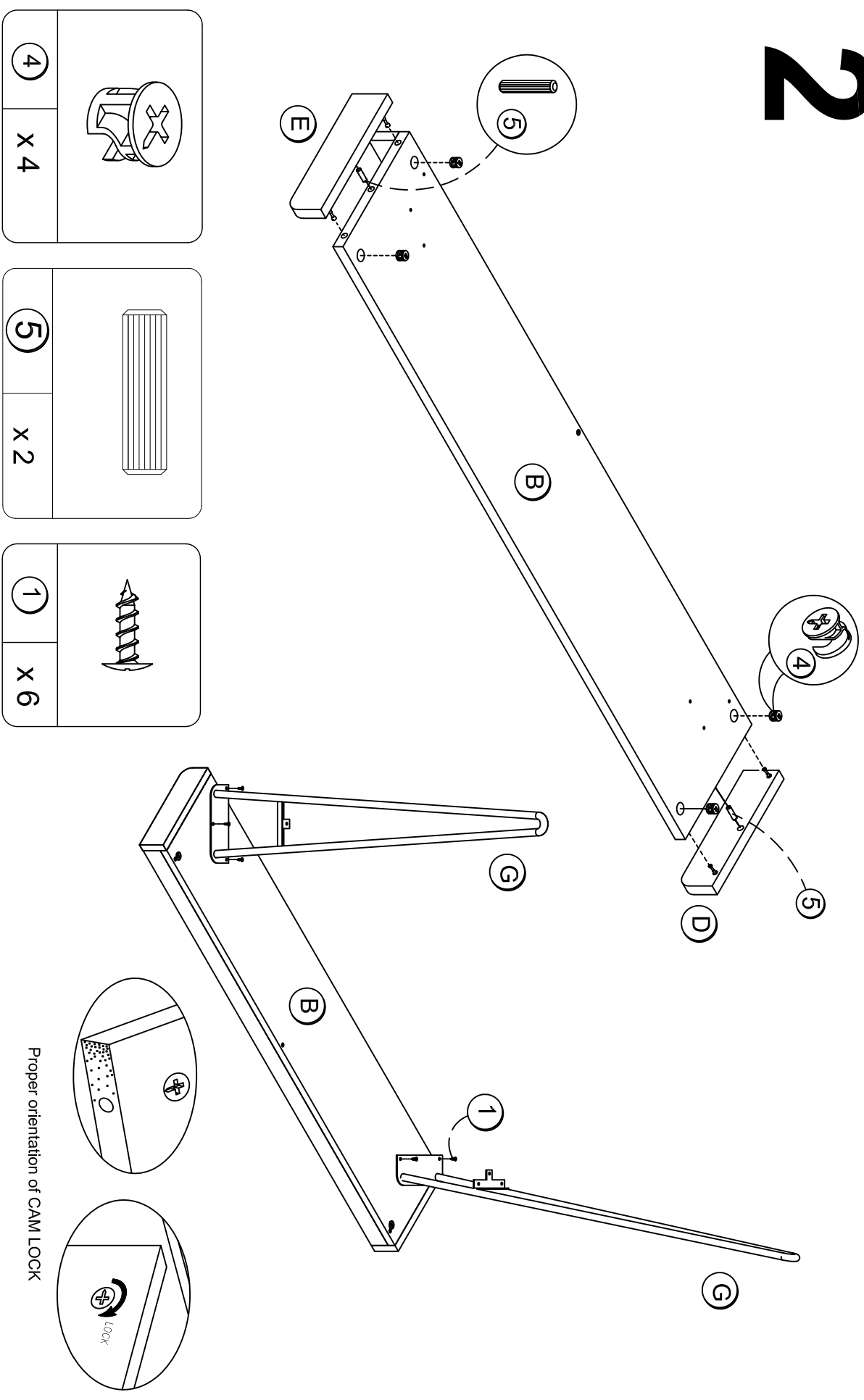

	X 4
--	-----

	X 2
--	-----

	X 6
--	-----

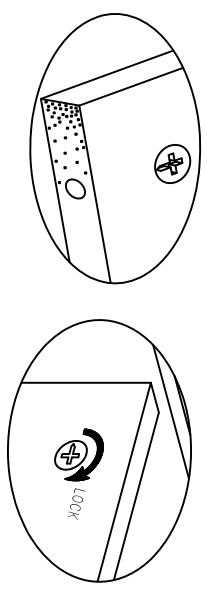

Proper orientation of CAM LOCK

3

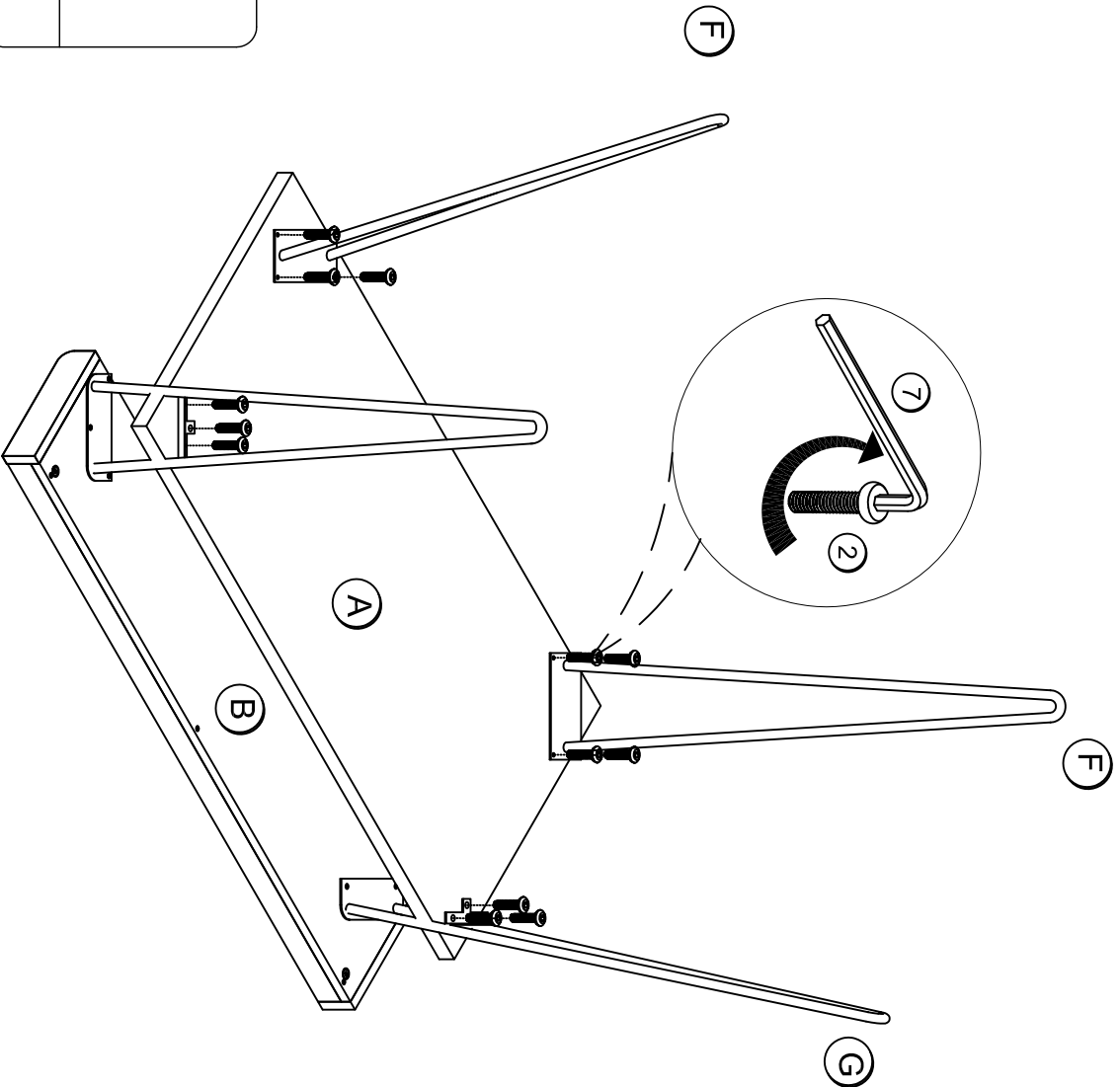
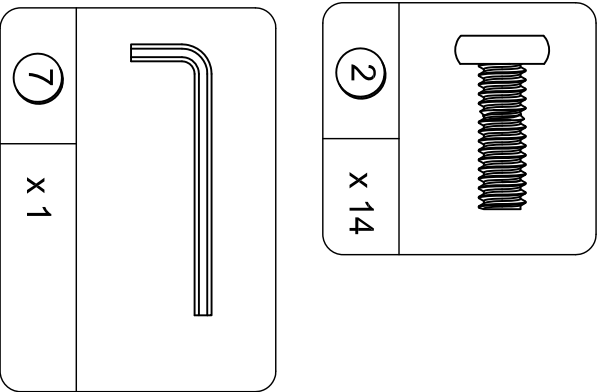

WEIGHT LIMITS :

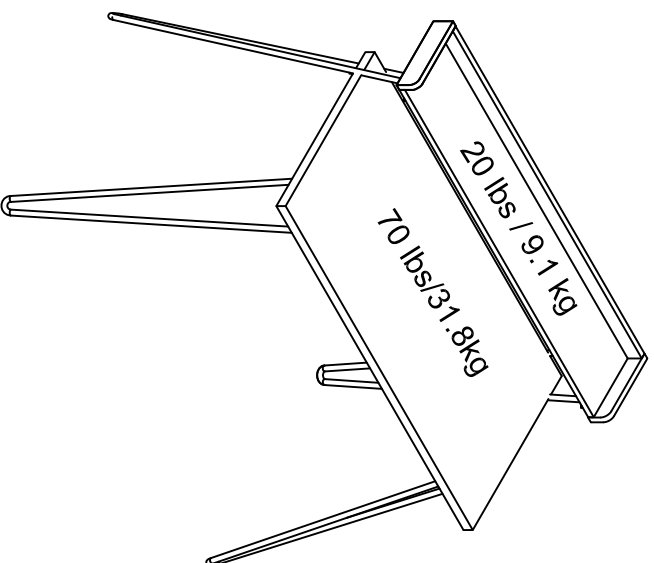

▲ WARNING

Please make sure that all the objects are removed before moving the assembled unit. The unit must be lifted by more than one person, not dragged or pushed. Failure to do so will cause product damage, instability, product collapse, and/or serious injury.

This unit has been designed to support the maximum loads shown. Exceeding these load limits could cause sagging, instability, product collapse, and/or serious injury.